

2.5



HCLB series

Orbital hydraulic motor

HCLB series orbital hydraulic motor is a cycloidal hydraulic motor with brake, which adopts a special end face compensation structure, which can achieve high volumetric efficiency and high starting efficiency under high pressure conditions.

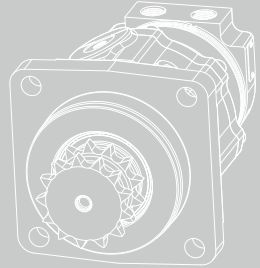

Contents

Overview	02
Advantages	02
Applications	02
Specification	03
Installation size	04
Length and weight	04
Allowable shaft load/bearing curve	05
Hydraulic diagram	06
Rotation direction	06
Ordering information	07



Overview

HCLB series orbital hydraulic motor is a cycloidal hydraulic motor with brake, which adopts a special end face compensation structure, which can achieve high volumetric efficiency and high starting efficiency under high pressure conditions, and is suitable for the walking drive of miniature skid steer loader. Built-in flushometer is optional.

Advantages

- Specially designed rotor with integrated internal flushing and self-lubrication function to improve the life of the rotating shaft
- Double tapered roller bearing design to withstand high radial loads
- High pressure face compensation disc to improve volumetric efficiency
- Direct sprocket output, easy to install and use
- Compact back cover design with integrated flushometer option

Applications

- Mini skid steer loaders (wheeled)
- Mini skid steer loader (crawler)
- Down-the-hole drilling rigs
- Non-excavation drilling rigs

Specification

Type		195	245	375
Displacement(cm ³ /rev.)		198	243.6	363
Max.speed(rpm)	Continuous	337	302	203
	Intermittent	409	362	241
Max.flow(L/min)	Continuous	68	76	76
	Intermittent	83	91	91
Max.torque(Nm)	Continuous	559	684	1017
	Intermittent	637	795	1175
Max.differential pressure(bar)	Continuous	207	207	207
	Intermittent	241	241	241
	Peak	276	276	276
Max.no-load starting pressure (bar)		8	10	10
Min.starting torque (Nm)	Max. continuous differential pressure	391	484	712
	Max. intermittent differential pressure	446	537	823

T-0141

- Intermittent working condition: The working time should be less than 6 seconds per minute under the intermittent working condition.
- Peak differential pressure: At peak differential pressure, the operating time is less than 0.6 seconds per minute.
- It is not recommended for the motor to work at simultaneous maximum torque and maximum speed.
- The filtration standard of ISO 4406 cleaning standard 20/18/15 is recommended.
- High quality anti-wear hydraulic fluids are recommended.
- When the temperature is 50° C, the minimum viscosity of the oil is recommended to be 20mm²/s.
- The recommended maximum operating temperature is 82°C .
- To assure best motor life, run motor 10-15 minutes in low speed high torque mode at approximately 50% of continuous pressure and 50% of continuous flow.

Installation size

Mount port: C11; Main shaft: S9

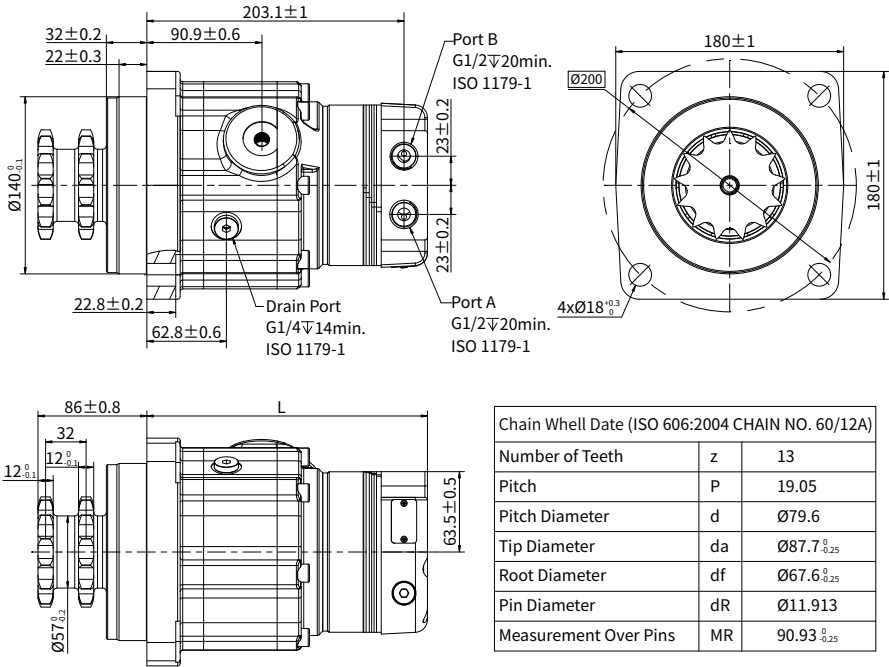

P-0147

Length and weight

Displacement cm ³ /rev.	L mm	Weight kg
195	215.7	30.1
245	221.6	30.5
375	236.8	31.6

T-0139

Note: Dimensions L are the length from the flange mounting surface to the rear end of the motor, and the tolerance is ± 1 mm.

Allowable shaft load/bearing curve

As shown in the figure, when the axial load is 0, the radial allowable load of the output shaft is related to the distance from the flange mounting surface to the load action point.

The solid line shows the allowable radial load of the bearing. It is based on L_{10} bearing life 2000 hrs at 100 RPM with rated output torque.

Any shaft load exceeding the values quoted in the curve will involve a risk of failure.

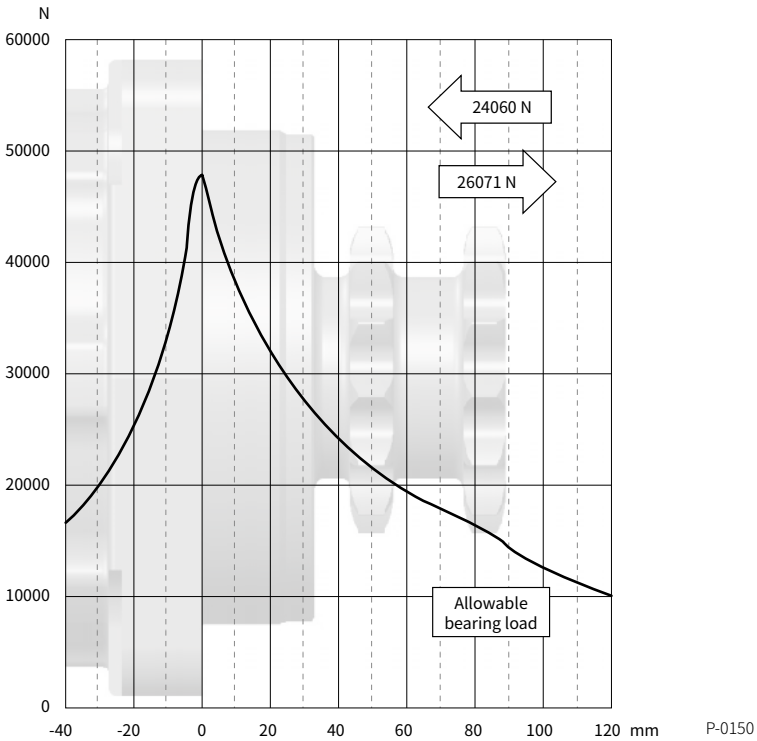

Schematic diagram of the functional module

· Schematic diagram with check valve

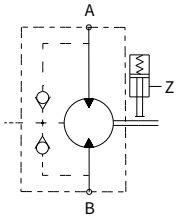

P-0151

· Schematic diagram with flushometer

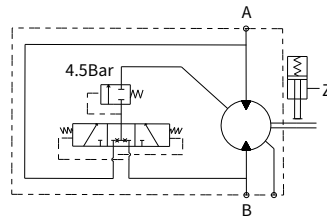

P-0149

Rotation direction: CW

When facing the motor shaft extension direction, port A is high pressure oil, the output shaft rotates CW; Otherwise, it rotates CCW.

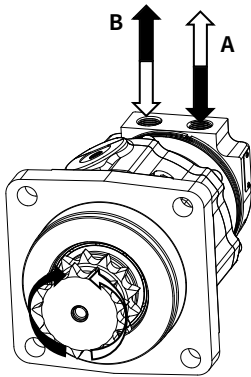

P-0152

Ordering information

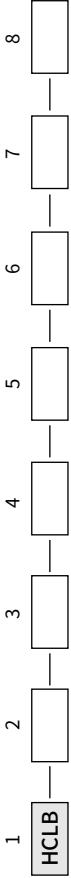

Pos.1	2	3	4	5	6	7	8
Series code	Displacement	Mount, Port	Output shaft	Rotation direction	Paint option	Valve options	Special features
HCLB	195 245 375	4 × φ18 Mount φ200 C11 pilot φ140 × 22, Port G1/2, Drain Port G1/4	Double-row sprocket shafts 13T, 60/12A(ISO606)	A CW R CCW	No Paint Black Hengli blue	A No flushing B Flushing volume 7.57L/min	A Standard, braking torque 700Nm F Free running V High temperature S Low temperature

T-0142

Note: When using the order information, the user can select the motor series, displacement, installation flange, port, shaft and other information. If the selected specification is not in the table or has special requirements, please contact us.

